

Inspiron 14 5000 Service Manual

Computer Model: Inspiron 14-5452
Regulatory Model: P64G
Regulatory Type: P64G005



Notes, cautions, and warnings



NOTE: A NOTE indicates important information that helps you make better use of your computer.



CAUTION: A CAUTION indicates either potential damage to hardware or loss of data and tells you how to avoid the problem.



WARNING: A WARNING indicates a potential for property damage, personal injury, or death.

© 2016 Dell Inc. All rights reserved. This product is protected by U.S. and international copyright and intellectual property laws. Dell and the Dell logo are trademarks of Dell Inc. in the United States and/or other jurisdictions. All other marks and names mentioned herein may be trademarks of their respective companies.

2016 – 08

Rev. A01

Contents

Before working inside your computer.....	10
Before you begin	10
Safety instructions.....	10
Recommended tools.....	11
After working inside your computer.....	13
Removing the battery.....	14
Procedure.....	14
Replacing the battery.....	16
Procedure.....	16
Removing the optical drive.....	17
Prerequisites.....	17
Procedure.....	17
Replacing the optical drive.....	20
Procedure.....	20
Post-requisites.....	20
Removing the keyboard.....	21
Prerequisites.....	21
Procedure.....	21
Replacing the keyboard.....	24
Procedure.....	24
Post-requisites.....	24



Removing the base cover.....	25
Prerequisites.....	25
Procedure.....	25
Replacing the base cover.....	27
Procedure.....	27
Post-requisites.....	27
Removing the coin-cell battery.....	28
Prerequisites.....	28
Procedure.....	28
Replacing the coin-cell battery.....	30
Procedure.....	30
Post-requisites.....	30
Removing the hard drive.....	31
Prerequisites.....	31
Procedure.....	31
Replacing the hard drive.....	34
Procedure.....	34
Post-requisites.....	34
Removing the memory modules.....	35
Prerequisites.....	35
Procedure.....	35
Replacing the memory modules.....	37
Procedure.....	37
Post-requisites.....	38



Removing the wireless card.....	39
Prerequisites.....	39
Procedure.....	39
Replacing the wireless card.....	41
Procedure.....	41
Post-requisites.....	41
Removing the computer base.....	42
Prerequisites.....	42
Procedure.....	42
Replacing the computer base.....	47
Procedure.....	47
Post-requisites.....	47
Removing the optical-drive interposer.....	48
Prerequisites.....	48
Procedure.....	48
Replacing the optical-drive interposer.....	50
Procedure.....	50
Post-requisites.....	50
Removing the heat-sink assembly.....	51
Prerequisites.....	51
Procedure.....	51
Replacing the heat-sink assembly.....	53
Procedure.....	53
Post-requisites.....	53



Removing the I/O board.....	54
Prerequisites.....	54
Procedure.....	54
Replacing the I/O board.....	56
Procedure.....	56
Post-requisites.....	56
Removing the system board.....	57
Prerequisites.....	57
Procedure.....	57
Replacing the system board.....	62
Procedure.....	62
Post-requisites.....	63
Removing the power-adapter port.....	64
Prerequisites.....	64
Procedure.....	64
Replacing the power-adapter port.....	66
Procedure.....	66
Post-requisites.....	66
Removing the power-button board.....	67
Prerequisites.....	67
Procedure.....	67
Replacing the power-button board.....	69
Procedure.....	69
Post-requisites.....	69



Removing the speakers.....	70
Prerequisites.....	70
Procedure.....	70
Replacing the speakers.....	72
Procedure.....	72
Post-requisites.....	72
Removing the display assembly.....	73
Prerequisites.....	73
Procedure.....	73
Replacing the display assembly.....	77
Procedure.....	77
Post-requisites.....	77
Removing the palm-rest assembly.....	78
Prerequisites.....	78
Procedure.....	78
Replacing the palm-rest assembly.....	80
Procedure.....	80
Post-requisites.....	80
Removing the display bezel.....	81
Prerequisites.....	81
Procedure.....	82
Replacing the display bezel.....	83
Procedure.....	83
Post-requisites.....	83



Removing the camera.....	84
Prerequisites.....	84
Procedure.....	84
Replacing the camera.....	86
Procedure.....	86
Post-requisites.....	86
Removing the display panel.....	87
Prerequisites.....	87
Procedure.....	87
Replacing the display panel.....	90
Procedure.....	90
Post-requisites.....	90
Removing the display hinges.....	92
Prerequisites.....	92
Procedure.....	92
Replacing the display hinges.....	94
Procedure.....	94
Post-requisites.....	94
Removing the display cable.....	95
Prerequisites.....	95
Procedure.....	95
Replacing the display cable.....	97
Procedure.....	97
Post-requisites.....	97



Removing the display back-cover and antenna assembly..... 98
Prerequisites..... 98
Procedure..... 99

Replacing the display back-cover and antenna assembly..... 100
Procedure..... 100
Post-requisites..... 100

Flashing the BIOS..... 102

Getting help and contacting Dell..... 103
Self-help resources..... 103
Contacting Dell..... 104



Before working inside your computer





NOTE: The images in this document may differ from your computer depending on the configuration you ordered.

Before you begin

- 1 Save and close all open files and exit all open applications.
- 2 Shut down your computer.

The shut-down instruction varies depending on the operating system installed on your computer.

- Windows 10: Click or tap **Start** →  **Power** → **Shut down**.
- Windows 8.1: On the **Start** screen, click or tap the power icon  → **Shut down**.
- Windows 7: Click or tap **Start** → **Shut down**.











NOTE: If you are using a different operating system, see the documentation of your operating system for shut-down instructions.

- 3 Disconnect your computer and all attached devices from their electrical outlets.
- 4 Disconnect all cables such as telephone cables and network cables, from your computer.
- 5 Disconnect all attached devices and peripherals, such as keyboard, mouse, and monitor, from your computer.
- 6 Remove any media card and optical disc from your computer, if applicable.

Safety instructions

Use the following safety guidelines to protect your computer from potential damage and ensure your personal safety.

-  **WARNING:** Before working inside your computer, read the safety information that shipped with your computer. For more safety best practices, see the Regulatory Compliance home page at www.dell.com/regulatory_compliance.
-  **WARNING:** Disconnect all power sources before opening the computer cover or panels. After you finish working inside the computer, replace all covers, panels, and screws before connecting to the electrical outlet.
-  **CAUTION:** To avoid damaging the computer, ensure that the work surface is flat and clean.
-  **CAUTION:** To avoid damaging the components and cards, handle them by their edges, and avoid touching pins and contacts.
-  **CAUTION:** You should only perform troubleshooting and repairs as authorized or directed by the Dell technical assistance team. Damage due to servicing that is not authorized by Dell is not covered by your warranty. See the safety instructions that shipped with the product or at www.dell.com/regulatory_compliance.
-  **CAUTION:** Before touching anything inside your computer, ground yourself by touching an unpainted metal surface, such as the metal at the back of the computer. While you work, periodically touch an unpainted metal surface to dissipate static electricity, which could harm internal components.
-  **CAUTION:** When you disconnect a cable, pull on its connector or on its pull tab, not on the cable itself. Some cables have connectors with locking tabs or thumb-screws that you must disengage before disconnecting the cable. When disconnecting cables, keep them evenly aligned to avoid bending any connector pins. When connecting cables, ensure that the ports and connectors are correctly oriented and aligned.
-  **CAUTION:** Press and eject any installed card from the media-card reader.

Recommended tools

The procedures in this document may require the following tools:

- Phillips screwdriver



- Plastic scribe



After working inside your computer



CAUTION: Leaving stray or loose screws inside your computer may severely damage your computer.

- 1 Replace all screws and ensure that no stray screws remain inside your computer.
- 2 Connect any external devices, peripherals, or cables you removed before working on your computer.
- 3 Replace any media cards, discs, or any other parts that you removed before working on your computer.
- 4 Connect your computer and all attached devices to their electrical outlets.
- 5 Turn on your computer.



Removing the battery



WARNING: Before working inside your computer, read the safety information that shipped with your computer and follow the steps in [Before working inside your computer](#). After working inside your computer, follow the instructions in [After working inside your computer](#). For more safety best practices, see the Regulatory Compliance home page at www.dell.com/regulatory_compliance.

Procedure

- 1 Close the display and turn the computer over.
- 2 Slide the battery-release latch to the unlock position.
- 3 Lift the battery at an angle and remove the battery from the battery bay.

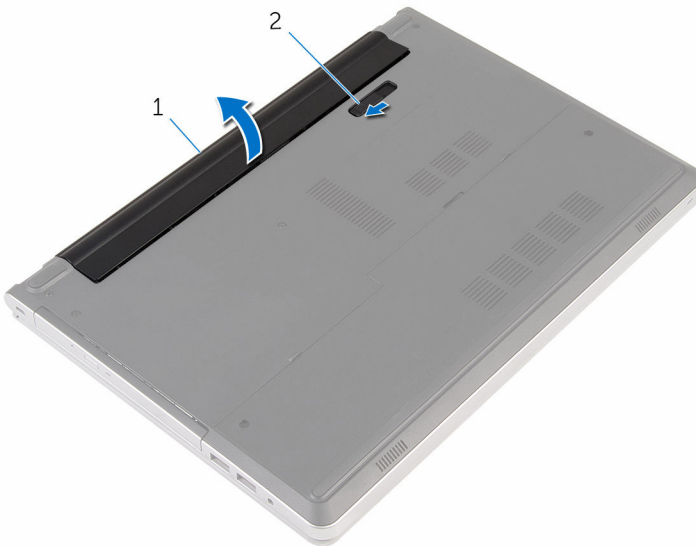

1 battery

2 battery-release latch

- 4 Turn the computer over, open the display, and press the power button for five seconds to ground the system board.



Replacing the battery



WARNING: Before working inside your computer, read the safety information that shipped with your computer and follow the steps in [Before working inside your computer](#). After working inside your computer, follow the instructions in [After working inside your computer](#). For more safety best practices, see the Regulatory Compliance home page at www.dell.com/regulatory_compliance.

Procedure

Slide the tabs on the battery into the slots on the battery bay and snap the battery into place.



NOTE: The battery-release latch returns to the lock position if the battery is installed properly.

Removing the optical drive



WARNING: Before working inside your computer, read the safety information that shipped with your computer and follow the steps in [Before working inside your computer](#). After working inside your computer, follow the instructions in [After working inside your computer](#). For more safety best practices, see the Regulatory Compliance home page at www.dell.com/regulatory_compliance.

Prerequisites

Remove the [battery](#).

Procedure

- 1 Remove the screw that secures the optical-drive assembly to the computer base.



- 2** Using a plastic scribe, slide the optical-drive assembly out of the optical-drive bay.

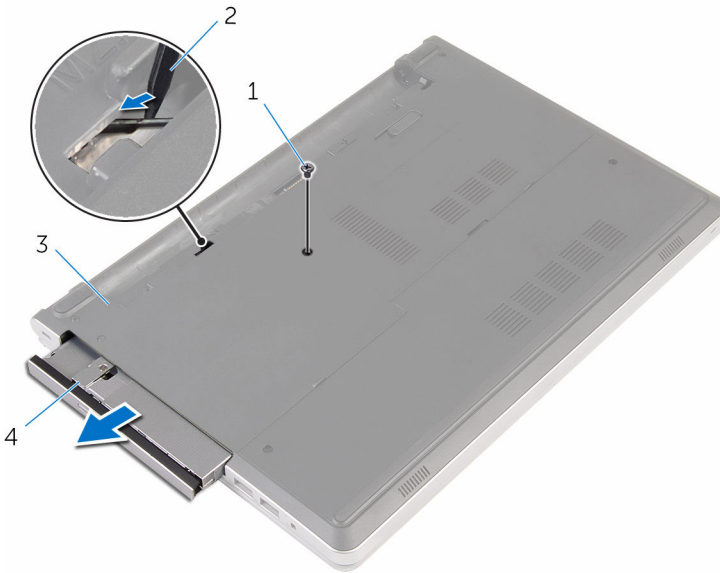

1 screw

2 plastic scribe

3 computer base

4 optical-drive assembly

- 3** Carefully pull the optical-drive bezel and remove it from the optical drive.

- 4 Remove the screws that secure the optical-drive bracket to the optical drive and remove the optical-drive bracket.

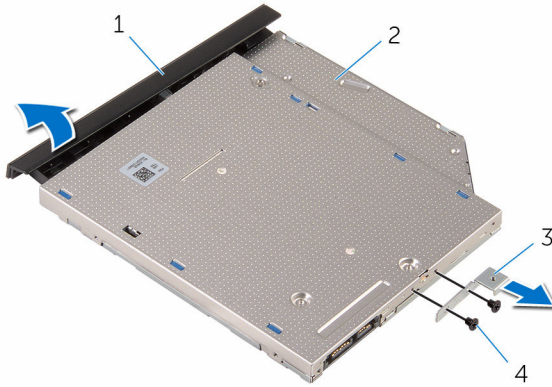

- | | | | |
|---|-----------------------|---|---------------|
| 1 | optical-drive bezel | 2 | optical drive |
| 3 | optical-drive bracket | 4 | screws (2) |



Replacing the optical drive



WARNING: Before working inside your computer, read the safety information that shipped with your computer and follow the steps in [Before working inside your computer](#). After working inside your computer, follow the instructions in [After working inside your computer](#). For more safety best practices, see the Regulatory Compliance home page at www.dell.com/regulatory_compliance.

Procedure

- 1 Align the screw holes on the optical-drive bracket with the screw holes on the optical drive.
- 2 Replace the screws that secure the optical-drive bracket to the optical drive.
- 3 Align the tabs on the optical-drive bezel with the slots on the optical-drive assembly and snap the optical-drive bezel into place.
- 4 Slide the optical-drive assembly into the optical-drive bay and align the screw hole on the optical-drive bracket with the screw hole on the computer base.
- 5 Replace the screw that secures the optical-drive assembly to the computer base.

Post-requisites

Replace the [battery](#).

Removing the keyboard



WARNING: Before working inside your computer, read the safety information that shipped with your computer and follow the steps in [Before working inside your computer](#). After working inside your computer, follow the instructions in [After working inside your computer](#). For more safety best practices, see the Regulatory Compliance home page at www.dell.com/regulatory_compliance.

Prerequisites

Remove the [battery](#).

Procedure

- 1 Turn the computer over and open the display as far as possible.



- 2** Using a plastic scribe, gently release the tabs that secure the keyboard to the palm-rest assembly.

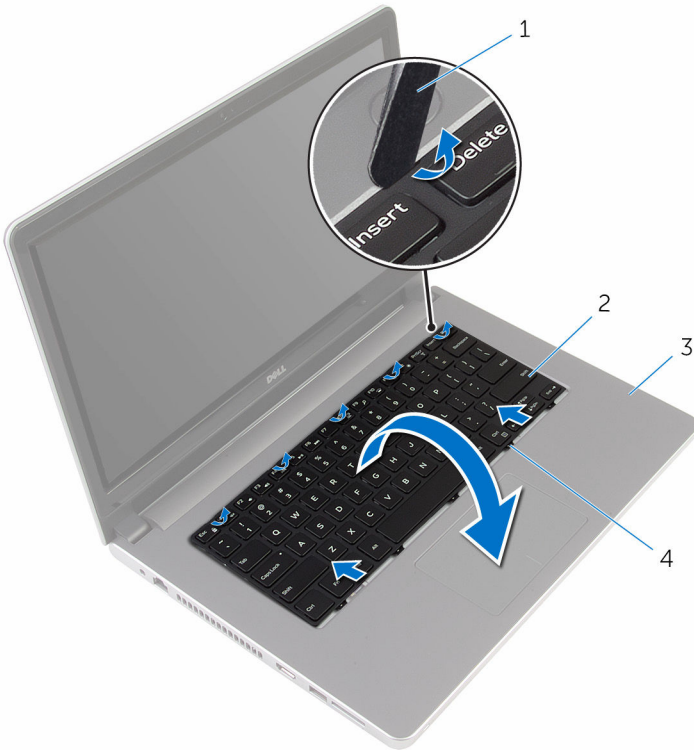

- | | | | |
|---|--------------------|---|----------|
| 1 | plastic scribe | 2 | keyboard |
| 3 | palm-rest assembly | 4 | tabs (5) |

- 3** Carefully turn the keyboard over and place it on the palm-rest assembly.

- 4 Lift the latches and disconnect the keyboard cable and the keyboard-backlight cable from the system board.

 **NOTE: The keyboard-backlight cable is present only if the laptop is shipped with a backlit keyboard.**

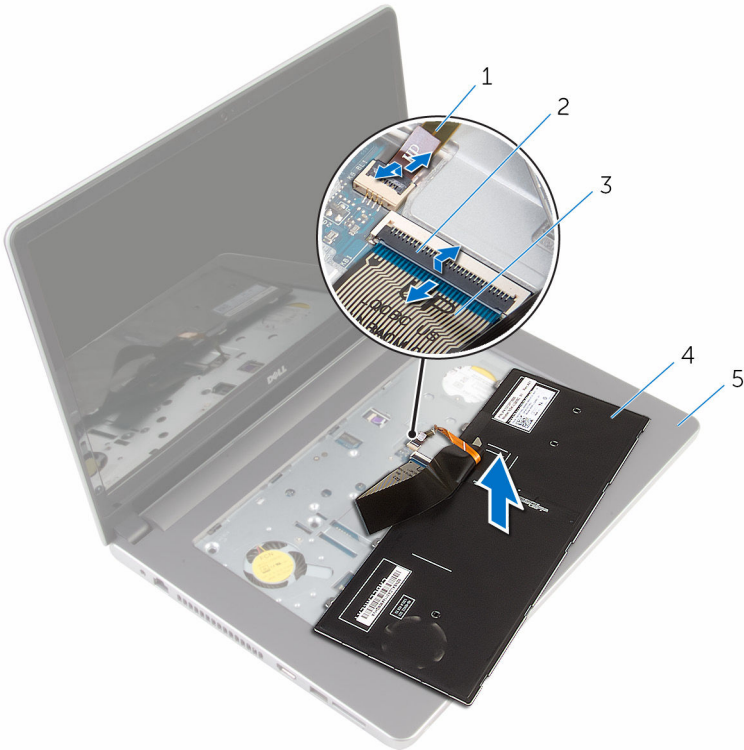

- | | | | |
|---|--------------------------|---|----------|
| 1 | keyboard-backlight cable | 2 | latch |
| 3 | keyboard cable | 4 | keyboard |
| 5 | palm-rest assembly | | |

- 5 Lift the keyboard, along with the cables, off the palm-rest assembly.



Replacing the keyboard



WARNING: Before working inside your computer, read the safety information that shipped with your computer and follow the steps in [Before working inside your computer](#). After working inside your computer, follow the instructions in [After working inside your computer](#). For more safety best practices, see the Regulatory Compliance home page at www.dell.com/regulatory_compliance.

Procedure

- 1 Slide the keyboard cable and the keyboard-backlight cable into their connectors on the system board and press down on the latches to secure the cables.
- 2 Carefully turn the keyboard over, slide the tabs on the keyboard into the slots on the palm-rest assembly, and snap the keyboard into place.
- 3 Close the display and turn the computer over.

Post-requisites

Replace the [battery](#).

Removing the base cover



WARNING: Before working inside your computer, read the safety information that shipped with your computer and follow the steps in [Before working inside your computer](#). After working inside your computer, follow the instructions in [After working inside your computer](#). For more safety best practices, see the Regulatory Compliance home page at www.dell.com/regulatory_compliance.

Prerequisites

Remove the [battery](#).

Procedure

- 1 Remove the screws that secure the base cover to the computer base.



2 Using your fingertips, gently pry the base cover off the computer base.

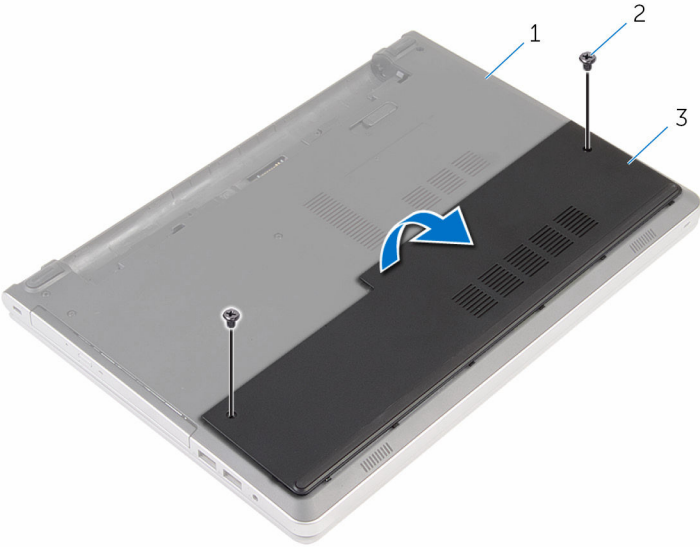

1 computer base

2 screws (2)

3 base cover

Replacing the base cover



WARNING: Before working inside your computer, read the safety information that shipped with your computer and follow the steps in [Before working inside your computer](#). After working inside your computer, follow the instructions in [After working inside your computer](#). For more safety best practices, see the Regulatory Compliance home page at www.dell.com/regulatory_compliance.

Procedure

- 1 Slide the tabs on the base cover into the slots on the computer base and snap the base cover into place.
- 2 Replace the screws that secure the base cover to the computer base.

Post-requisites

Replace the [battery](#).



Removing the coin-cell battery

 **WARNING:** Before working inside your computer, read the safety information that shipped with your computer and follow the steps in [Before working inside your computer](#). After working inside your computer, follow the instructions in [After working inside your computer](#). For more safety best practices, see the Regulatory Compliance home page at www.dell.com/regulatory_compliance.

 **CAUTION:** Removing the coin-cell battery resets the BIOS setup program's settings to default. It is recommended that you note the BIOS setup program's settings before removing the coin-cell battery.

Prerequisites

- 1 Remove the [battery](#).
- 2 Remove the [base cover](#).

Procedure

Using a plastic scribe, gently pry the coin-cell battery out of the battery socket on the system board.



- 1 plastic scribe
- 3 battery socket

- 2 coin-cell battery

Replacing the coin-cell battery



WARNING: Before working inside your computer, read the safety information that shipped with your computer and follow the steps in [Before working inside your computer](#). After working inside your computer, follow the instructions in [After working inside your computer](#). For more safety best practices, see the Regulatory Compliance home page at www.dell.com/regulatory_compliance.

Procedure

With the positive-side facing up, snap the coin-cell battery into the battery socket on the system board.

Post-requisites

- 1 Replace the [base cover](#).
- 2 Replace the [battery](#).

Removing the hard drive

 **WARNING:** Before working inside your computer, read the safety information that shipped with your computer and follow the steps in [Before working inside your computer](#). After working inside your computer, follow the instructions in [After working inside your computer](#). For more safety best practices, see the Regulatory Compliance home page at www.dell.com/regulatory_compliance.

 **CAUTION:** Hard drives are fragile. Exercise care when handling the hard drive.

 **CAUTION:** To avoid data loss, do not remove the hard drive while the computer is in sleep or on state.

Prerequisites

- 1 Remove the [battery](#).
- 2 Remove the [base cover](#).

Procedure

- 1 Lift the latch and disconnect the hard-drive cable from the system board.
- 2 Remove the screws that secure the hard-drive assembly to the computer base.



3 Lift the hard-drive assembly off the computer base.

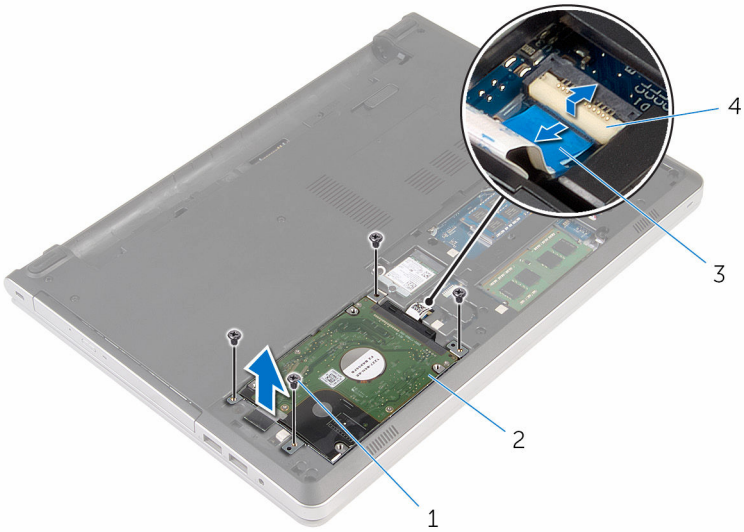

1 screws (4)

2 hard-drive assembly

3 hard-drive cable

4 latch

- 4 Disconnect the hard-drive interposer from the hard-drive assembly.

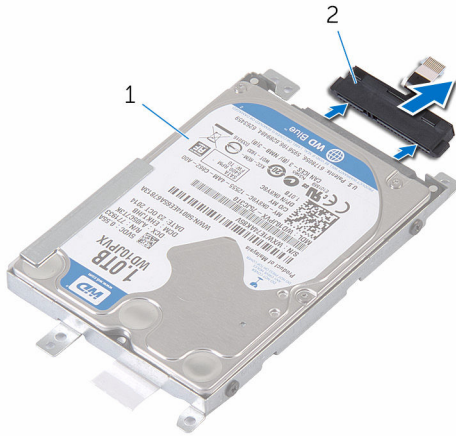

1 hard-drive assembly

2 hard-drive interposer

- 5 Remove the screws that secure the hard-drive bracket to the hard drive and lift the hard drive off the hard-drive bracket.

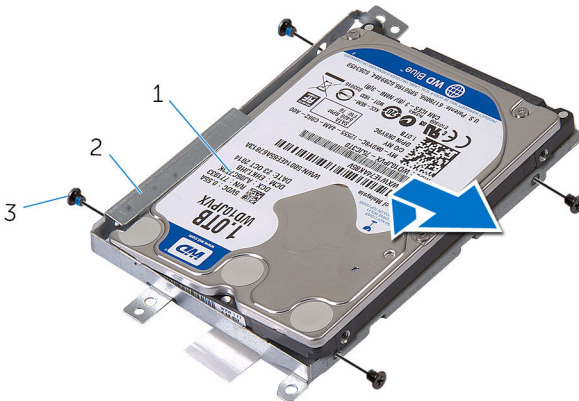

1 hard drive

2 hard-drive bracket

3 screws (4)



Replacing the hard drive

 **WARNING:** Before working inside your computer, read the safety information that shipped with your computer and follow the steps in [Before working inside your computer](#). After working inside your computer, follow the instructions in [After working inside your computer](#). For more safety best practices, see the Regulatory Compliance home page at www.dell.com/regulatory_compliance.

 **CAUTION:** Hard drives are fragile. Exercise care when handling the hard drive.

Procedure

- 1 Place the hard drive over the hard-drive bracket.
- 2 Align the screw holes on the hard-drive bracket with the screw holes on the hard drive.
- 3 Replace the screws that secure the hard drive to the hard-drive bracket.
- 4 Connect the hard-drive interposer to the hard-drive assembly.
- 5 Slide the hard-drive assembly in the computer base and align the screw holes on the hard-drive assembly with the screw holes on the computer base.
- 6 Replace the screws that secure the hard-drive assembly to the computer base.
- 7 Connect the hard-drive cable to the system board.

Post-requisites

- 1 Replace the [base cover](#).
- 2 Replace the [battery](#).

Removing the memory modules



WARNING: Before working inside your computer, read the safety information that shipped with your computer and follow the steps in [Before working inside your computer](#). After working inside your computer, follow the instructions in [After working inside your computer](#). For more safety best practices, see the Regulatory Compliance home page at www.dell.com/regulatory_compliance.

Prerequisites

- 1 Remove the [battery](#).
- 2 Remove the [base cover](#).

Procedure



NOTE: The number of the memory-module slots may be different on your computer depending on the configuration ordered.

- 1 Using your fingertips, spread apart the securing clips on each end of the memory-module slot until the memory module pops up.



- 2 Slide and remove the memory module from the memory-module slot.

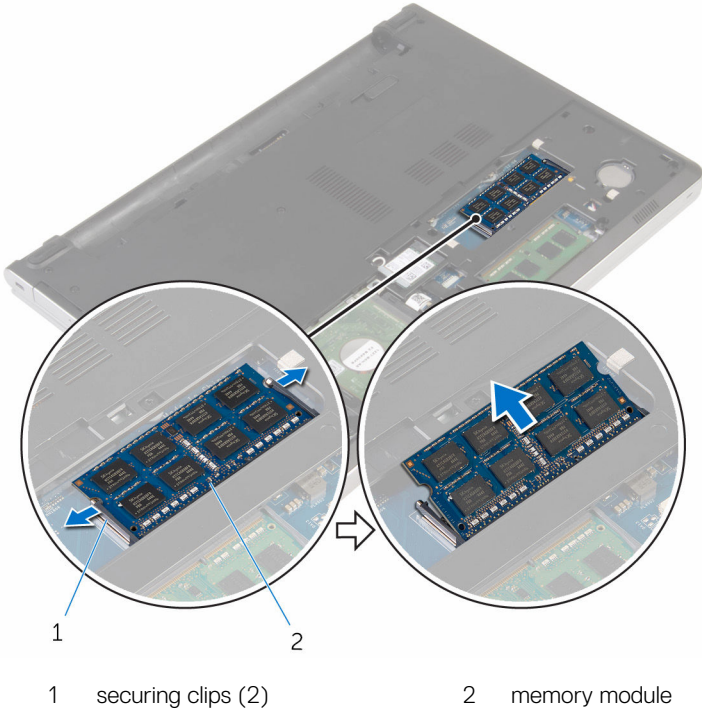

Replacing the memory modules



WARNING: Before working inside your computer, read the safety information that shipped with your computer and follow the steps in [Before working inside your computer](#). After working inside your computer, follow the instructions in [After working inside your computer](#). For more safety best practices, see the Regulatory Compliance home page at www.dell.com/regulatory_compliance.

Procedure

- 1 Align the notch on the memory module with the tab on the memory-module slot.



- Slide the memory module firmly into the slot at an angle and gently press the memory module down until it clicks into place.

 **NOTE: If you do not hear the click, remove the memory module and reinstall it.**

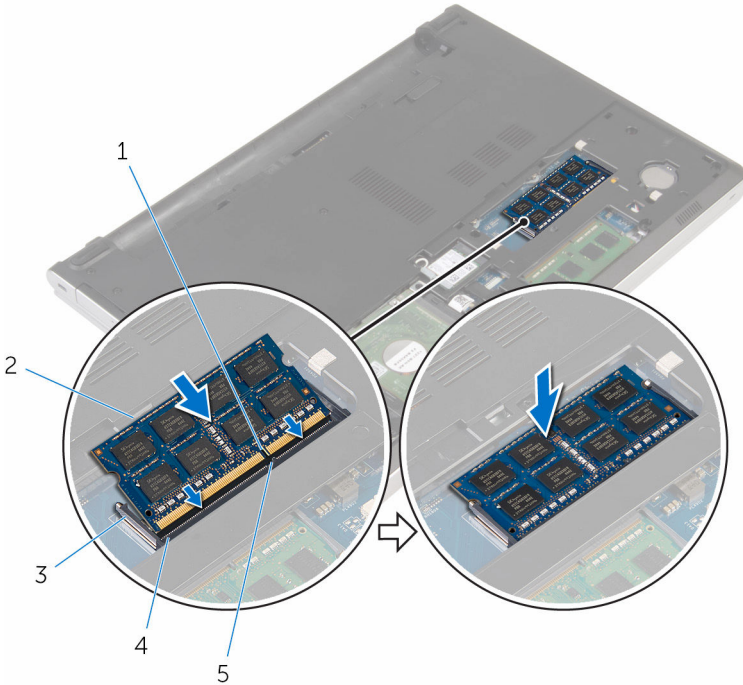

1 notch

3 securing clips

5 tab

2 memory module

4 memory-module slot

Post-requisites

- Replace the [base cover](#).
- Replace the [battery](#).

Removing the wireless card



WARNING: Before working inside your computer, read the safety information that shipped with your computer and follow the steps in [Before working inside your computer](#). After working inside your computer, follow the instructions in [After working inside your computer](#). For more safety best practices, see the Regulatory Compliance home page at www.dell.com/regulatory_compliance.

Prerequisites

- 1 Remove the [battery](#).
- 2 Remove the [base cover](#).

Procedure

- 1 Remove the screw that secures the wireless-card bracket to the wireless card.
- 2 Lift the wireless-card bracket off the wireless card.
- 3 Disconnect the antenna cables from the wireless card.



- 4 Slide and remove the wireless card out of the wireless-card slot.

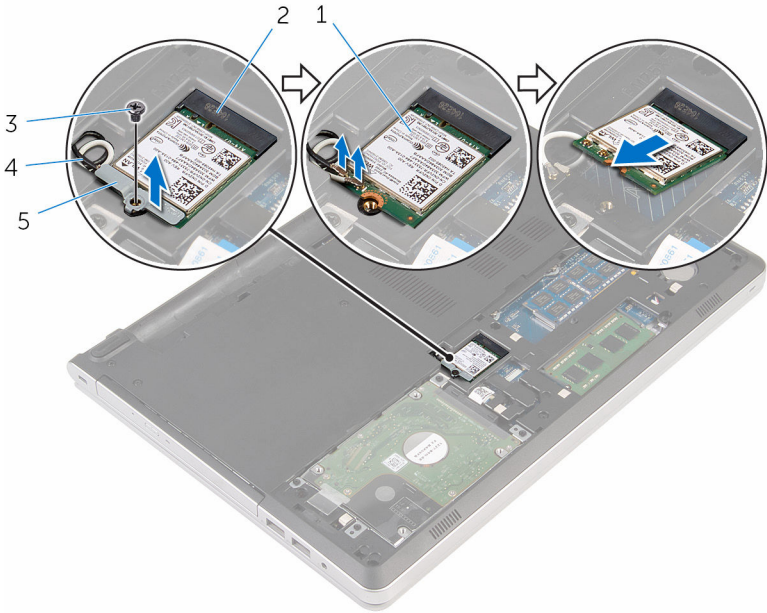

- | | | | |
|---|-----------------------|---|--------------------|
| 1 | wireless card | 2 | wireless-card slot |
| 3 | screw | 4 | antenna cables (2) |
| 5 | wireless-card bracket | | |

Replacing the wireless card



WARNING: Before working inside your computer, read the safety information that shipped with your computer and follow the steps in [Before working inside your computer](#). After working inside your computer, follow the instructions in [After working inside your computer](#). For more safety best practices, see the Regulatory Compliance home page at www.dell.com/regulatory_compliance.

Procedure



CAUTION: To avoid damage to the wireless card, do not place any cables under it.

- 1 Align the notch on the wireless card with the tab on the wireless-card slot and slide the card into the slot.
- 2 Connect the antenna cables to the wireless card. The following table provides the antenna-cable color scheme for the wireless card supported by your computer:

Connectors on the wireless card	Antenna-cable color
Main (white triangle)	White
Auxiliary (black triangle)	Black

- 3 Align the screw hole on the wireless-card bracket with the screw-hole on the wireless card and replace the screw that secures the wireless-card bracket to the wireless card.

Post-requisites

- 1 Replace the [base cover](#).
- 2 Replace the [battery](#).



Removing the computer base



WARNING: Before working inside your computer, read the safety information that shipped with your computer and follow the steps in [Before working inside your computer](#). After working inside your computer, follow the instructions in [After working inside your computer](#). For more safety best practices, see the Regulatory Compliance home page at www.dell.com/regulatory_compliance.

Prerequisites

- 1 Remove the [battery](#).
- 2 Remove the [optical drive](#).
- 3 Remove the [base cover](#).
- 4 Follow the procedure from step 1 to step 3 in "[Removing the hard drive](#)".
- 5 Remove the [wireless card](#).
- 6 Remove the [keyboard](#).

Procedure

- 1 Lift the latch and disconnect the optical-drive cable from the system board.

- 2** Remove the screws that secure the computer base to the palm-rest assembly.

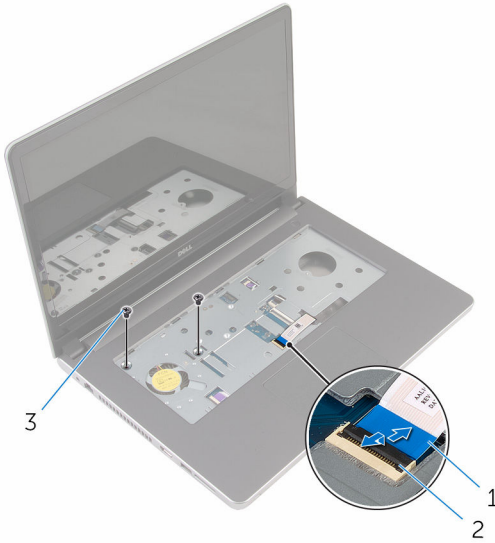

- 1 optical-drive cable 2 latch
3 screws (2)

- 3** Close the display and turn the computer over.



- 4 Remove the screws that secure the computer base to the palm-rest assembly.

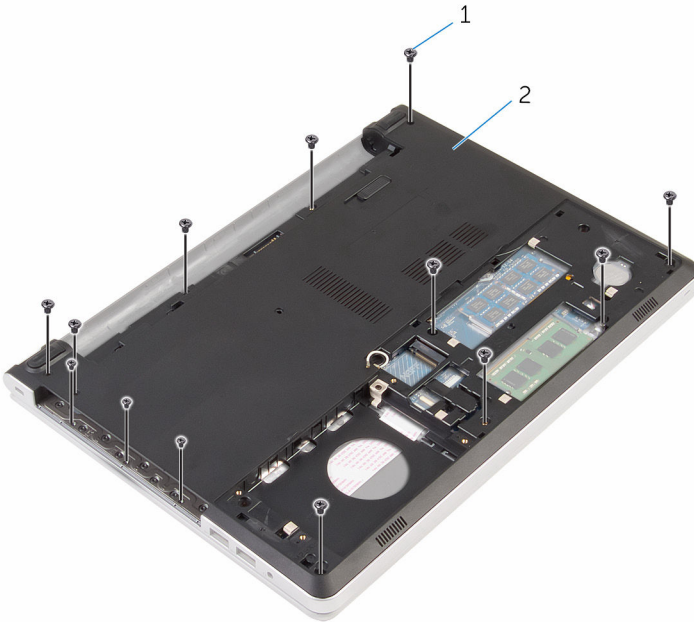

1 screws (13)

2 computer base

- 5 Using a plastic scribe, pry up the computer base from the palm-rest assembly, starting from the area around the display hinges.

6 Lift the computer base off the palm-rest assembly.

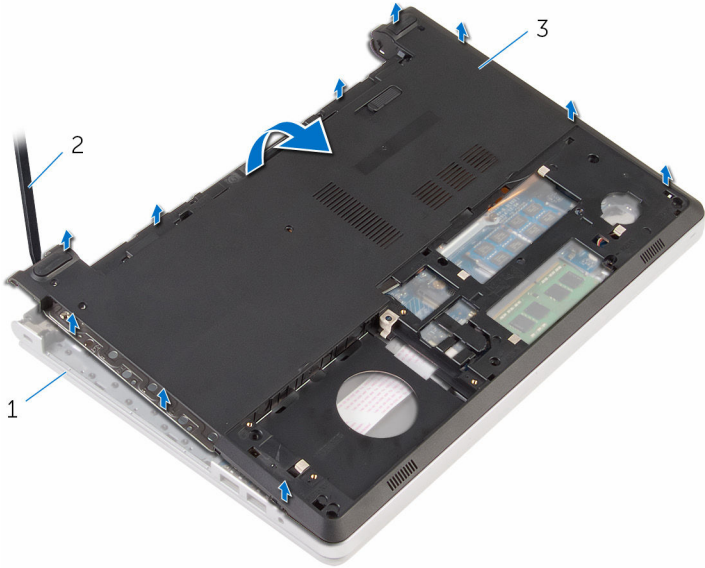

1 palm-rest assembly

2 plastic scribe

3 computer base



- 7 Lift the optical-drive interposer along with the cable off the computer base.

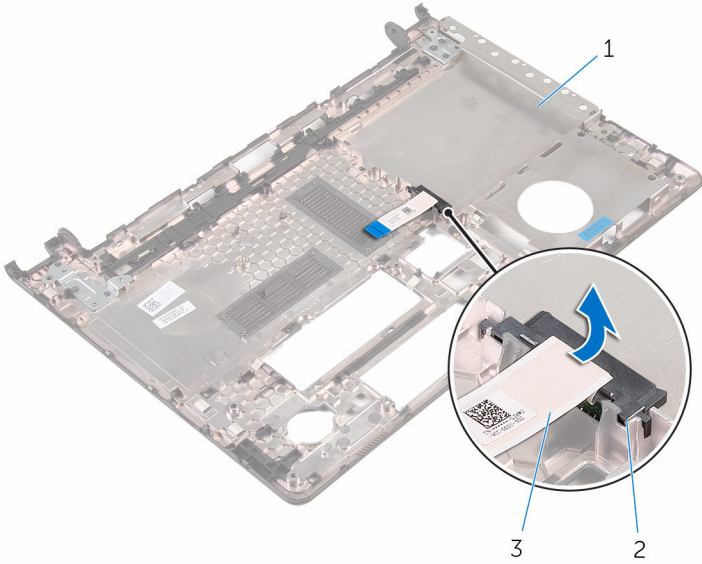

- 1 computer base
3 optical-drive cable

- 2 optical-drive interposer

Replacing the computer base



WARNING: Before working inside your computer, read the safety information that shipped with your computer and follow the steps in [Before working inside your computer](#). After working inside your computer, follow the instructions in [After working inside your computer](#). For more safety best practices, see the Regulatory Compliance home page at www.dell.com/regulatory_compliance.

Procedure

- 1 Align the optical-drive interposer with the slot on the computer base and snap it into place.
- 2 Turn the computer base over.
- 3 Align and place the computer base on the palm-rest assembly.
- 4 Press the computer base down along the edges to snap it into place.
- 5 Replace the screws that secure the computer base to the palm-rest assembly.
- 6 Turn the computer over and open the display.
- 7 Replace the screws that secure the computer base to the palm-rest assembly.
- 8 Slide the optical-drive cable into the connector on the system board and press down the latch to secure the cable.

Post-requisites

- 1 Replace the [keyboard](#).
- 2 Replace the [wireless card](#).
- 3 Follow the procedure from step 5 to step 7 in "[Replacing the hard drive](#)".
- 4 Replace the [optical drive](#).
- 5 Replace the [base cover](#).
- 6 Replace the [battery](#).



Removing the optical-drive interposer



WARNING: Before working inside your computer, read the safety information that shipped with your computer and follow the steps in [Before working inside your computer](#). After working inside your computer, follow the instructions in [After working inside your computer](#). For more safety best practices, see the Regulatory Compliance home page at www.dell.com/regulatory_compliance.

Prerequisites

- 1 Remove the [battery](#).
- 2 Remove the [base cover](#).
- 3 Remove the [optical drive](#).
- 4 Follow the procedure from step 1 to step 3 in "[Removing the hard drive](#)".
- 5 Remove the [wireless card](#).
- 6 Remove the [keyboard](#).

Procedure

- 1 Follow the procedure from step 1 to step 5 in "[Removing the computer base](#)".
- 2 Turn the computer base and place it on a flat surface.

- 3** Lift the optical-drive interposer along with the cable off the computer base.

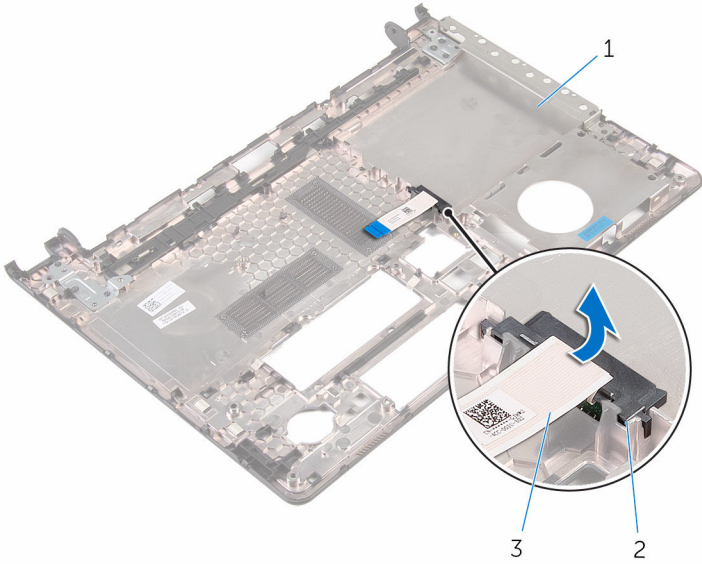

- 1 computer base
3 optical-drive cable

- 2 optical-drive interposer



Replacing the optical-drive interposer



WARNING: Before working inside your computer, read the safety information that shipped with your computer and follow the steps in [Before working inside your computer](#). After working inside your computer, follow the instructions in [After working inside your computer](#). For more safety best practices, see the Regulatory Compliance home page at www.dell.com/regulatory_compliance.



Procedure

- 1 Align the optical-drive interposer with the slot on the computer base and snap it into place.
- 2 Follow the procedure from step 1 to step 5 in "[Replacing the computer base](#)".

Post-requisites

- 1 Replace the [keyboard](#).
- 2 Replace the [wireless card](#).
- 3 Follow the procedure from step 5 to step 7 in "[Replacing the hard drive](#)".
- 4 Replace the [optical drive](#).
- 5 Replace the [base cover](#).
- 6 Replace the [battery](#).

Removing the heat-sink assembly

-  **WARNING:** Before working inside your computer, read the safety information that shipped with your computer and follow the steps in [Before working inside your computer](#). After working inside your computer, follow the instructions in [After working inside your computer](#). For more safety best practices, see the Regulatory Compliance home page at www.dell.com/regulatory_compliance.
-  **WARNING:** The heat sink may become hot during normal operation. Allow sufficient time for the heat sink to cool before you touch it.
-  **CAUTION:** For maximum cooling of the processor, do not touch the heat transfer areas on the heat sink. The oils in your skin can reduce the heat transfer capability of the thermal grease.

Prerequisites

- 1 Remove the [battery](#).
- 2 Remove the [base cover](#).
- 3 Remove the [optical drive](#).
- 4 Follow the procedure from step 1 to step 3 in "[Removing the hard drive](#)".
- 5 Remove the [wireless card](#).
- 6 Remove the [keyboard](#).
- 7 Remove the [computer base](#).

Procedure

 **NOTE:** The number of screws and the appearance of the heat-sink assembly may be different on your computer depending on the configuration ordered.

- 1 Disconnect the fan cable from the system board.
- 2 In sequential order, as indicated on the heat-sink assembly, loosen the captive screws that secure the heat-sink assembly to the system board.



- 3** Remove the screws that secure the heat-sink assembly to the system board.
- 4** Lift the heat-sink assembly off the system board.

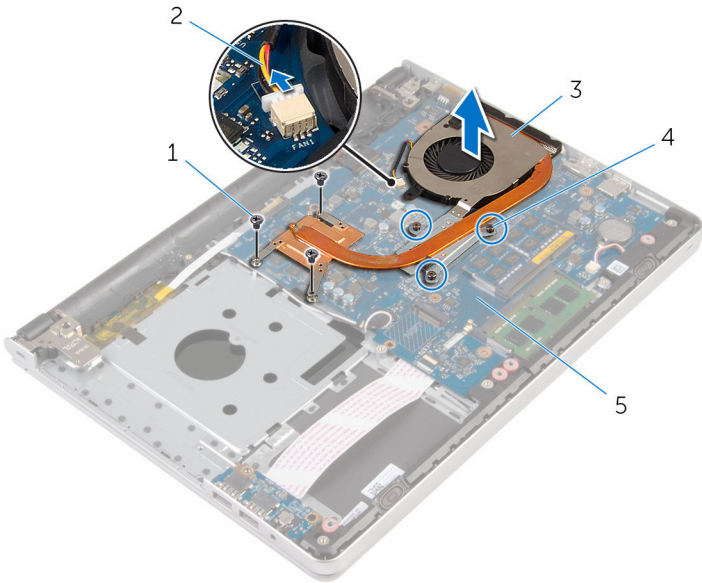

- | | | | |
|---|--------------------|---|--------------------|
| 1 | screws (3) | 2 | fan cable |
| 3 | heat-sink assembly | 4 | captive screws (3) |
| 5 | system board | | |

Replacing the heat-sink assembly



WARNING: Before working inside your computer, read the safety information that shipped with your computer and follow the steps in [Before working inside your computer](#). After working inside your computer, follow the instructions in [After working inside your computer](#). For more safety best practices, see the Regulatory Compliance home page at www.dell.com/regulatory_compliance.



CAUTION: Incorrect alignment of the heat sink can damage the system board and processor.



NOTE: The original thermal grease can be reused if the original system board and fan are reinstalled together. If either the system board or the fan is replaced, use the thermal pad provided in the kit to ensure that thermal conductivity is achieved.

Procedure

- 1 Align the screw holes on the heat-sink assembly with the screw holes on the system board.
- 2 In sequential order, as indicated on the heat-sink assembly, tighten the captive screws that secure the heat-sink assembly to the system board.
- 3 Replace the screws that secure the heat-sink assembly to the system board.
- 4 Connect the fan cable to the system board.

Post-requisites

- 1 Replace the [computer base](#).
- 2 Replace the [keyboard](#).
- 3 Replace the [wireless card](#).
- 4 Follow the procedure from step 5 to step 7 in "[Replacing the hard drive](#)".
- 5 Replace the [memory modules](#).
- 6 Replace the [optical drive](#).
- 7 Replace the [base cover](#).
- 8 Replace the [battery](#).



Removing the I/O board



WARNING: Before working inside your computer, read the safety information that shipped with your computer and follow the steps in [Before working inside your computer](#). After working inside your computer, follow the instructions in [After working inside your computer](#). For more safety best practices, see the Regulatory Compliance home page at www.dell.com/regulatory_compliance.

Prerequisites

- 1 Remove the [battery](#).
- 2 Remove the [base cover](#).
- 3 Remove the [optical drive](#).
- 4 Follow the procedure from step 1 to step 3 in "[Removing the hard drive](#)".
- 5 Remove the [wireless card](#).
- 6 Remove the [keyboard](#).
- 7 Remove the [computer base](#).

Procedure

- 1 Remove the screw that secures the I/O board to the palm-rest assembly.
- 2 Lift the I/O board and turn it over.
- 3 Lift the latch and disconnect the I/O-board cable from the I/O board.

4 Lift the I/O board off the palm-rest assembly.

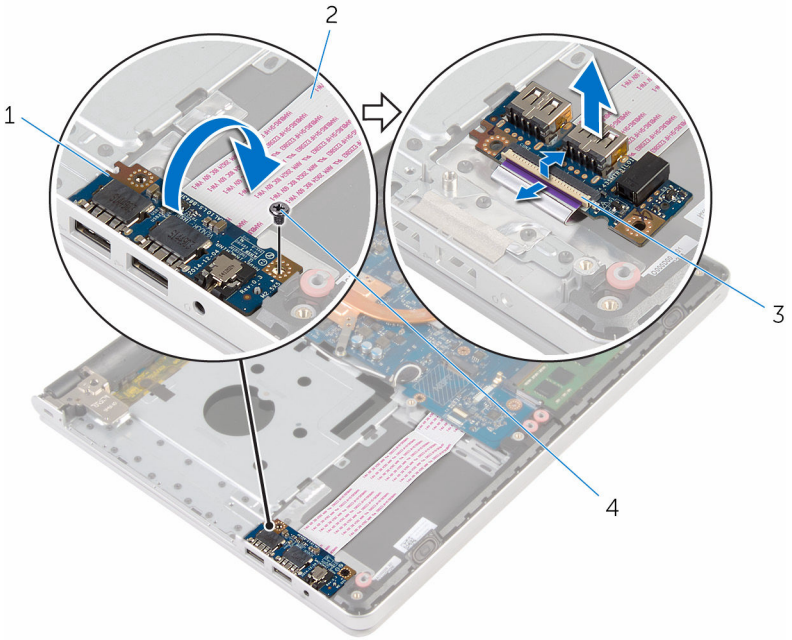

1 I/O board

2 I/O-board cable

3 latch

4 screw



Replacing the I/O board



WARNING: Before working inside your computer, read the safety information that shipped with your computer and follow the steps in [Before working inside your computer](#). After working inside your computer, follow the instructions in [After working inside your computer](#). For more safety best practices, see the Regulatory Compliance home page at www.dell.com/regulatory_compliance.

Procedure

- 1 Slide the I/O-board cable into the connector on the I/O-board and press down on the latch to secure the cable.
- 2 Turn the I/O board over and align the screw hole on the I/O board with the screw hole on the palm-rest assembly.
- 3 Replace the screw that secures the I/O board to the palm-rest assembly.

Post-requisites

- 1 Replace the [computer base](#).
- 2 Replace the [keyboard](#).
- 3 Replace the [wireless card](#).
- 4 Follow the procedure from step 5 to step 7 in "[Replacing the hard drive](#)".
- 5 Replace the [optical drive](#).
- 6 Replace the [base cover](#).
- 7 Replace the [battery](#).

Removing the system board



WARNING: Before working inside your computer, read the safety information that shipped with your computer and follow the steps in [Before working inside your computer](#). After working inside your computer, follow the instructions in [After working inside your computer](#). For more safety best practices, see the Regulatory Compliance home page at www.dell.com/regulatory_compliance.



NOTE: Your computer's Service Tag is stored in the system board. You must enter the Service Tag in the BIOS setup program after you replace the system board.



NOTE: Replacing the system board removes any changes you have made to the BIOS using the BIOS setup program. You must make the appropriate changes again after you replace the system board.



NOTE: Before disconnecting the cables from the system board, note the location of the connectors so that you can reconnect the cables correctly after you replace the system board.

Prerequisites

- 1 Remove the [battery](#).
- 2 Remove the [base cover](#).
- 3 Remove the [optical drive](#).
- 4 Remove the [memory modules](#).
- 5 Follow the procedure from step 1 to step 3 in "[Removing the hard drive](#)".
- 6 Remove the [wireless card](#).
- 7 Remove the [keyboard](#).
- 8 Remove the [computer base](#).
- 9 Remove the [heat-sink assembly](#).
- 10 Remove the [I/O board](#).

Procedure

- 1 Turn the computer over and open the display as far as possible.



- 2 Lift the latches and disconnect the touch-pad cable and the power-button board cable from the system board.

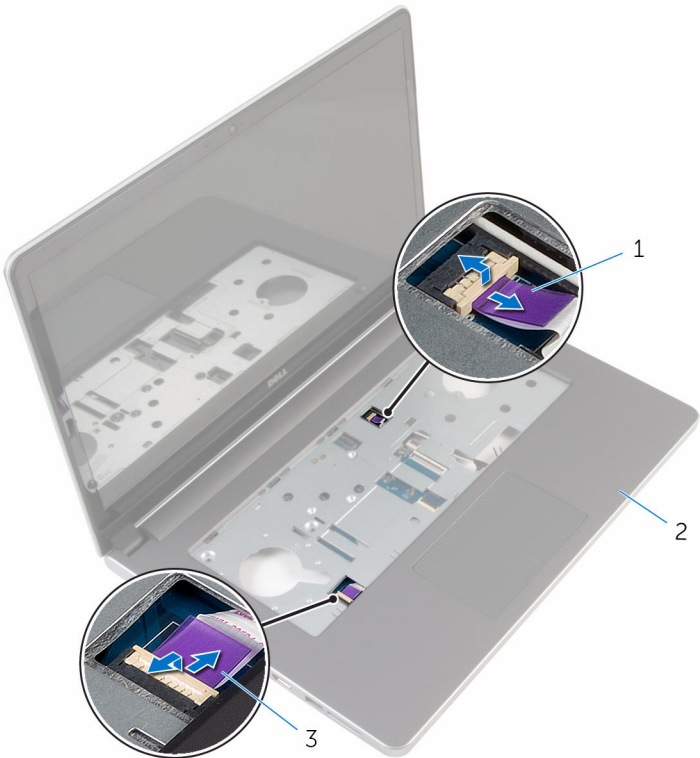

- 1 power-button board cable
- 2 palm-rest assembly
- 3 touch-pad cable

- 3 Close the display and turn the computer over.
- 4 Lift the latch and disconnect the display cable from the system board.
- 5 Disconnect the speaker cable from the system board.
- 6 Peel the tape from the antenna cables.

7 Remove the screw that secures the system board to the palm-rest assembly.

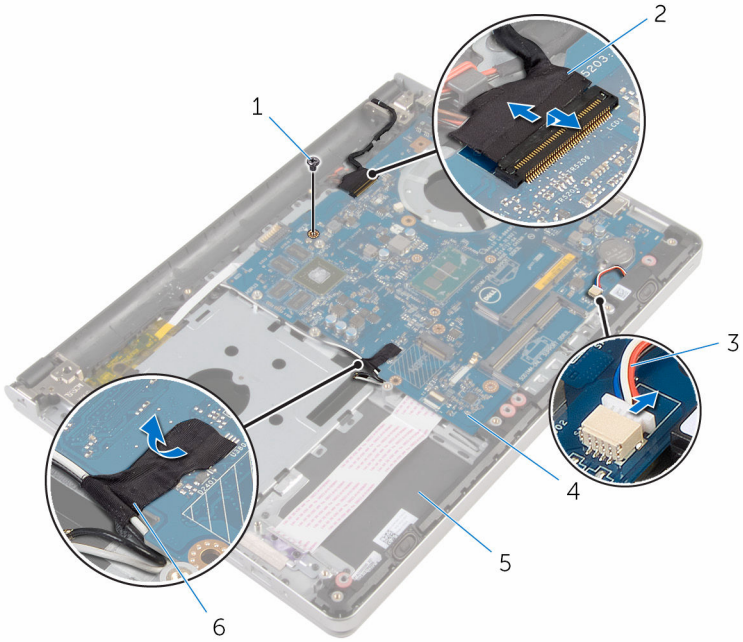

1 screw

2 display cable

3 speaker cable

4 system board

5 palm-rest assembly

6 tape



- 8** Lift the system board off the palm-rest assembly and carefully turn the system board over.

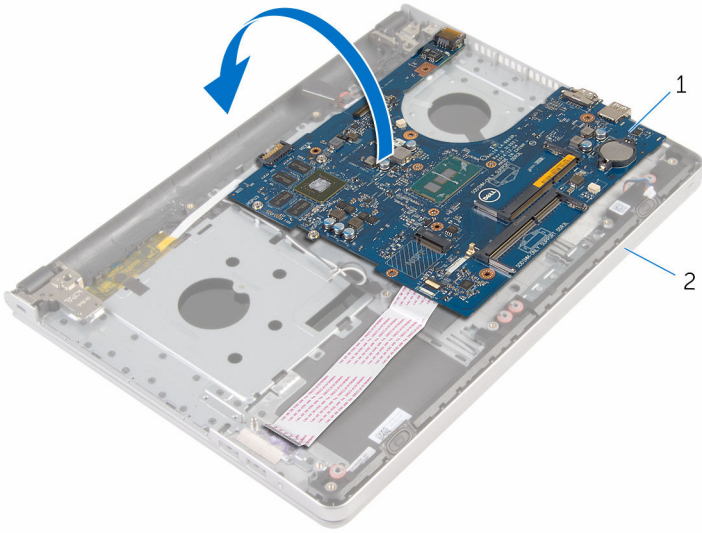

1 system board

2 palm-rest assembly

- 9** Disconnect the power-adaptor port cable from the system board.
- 10** Lift the latch and disconnect the I/O-board cable from the system board.

11 Lift the system board off the palm-rest assembly.

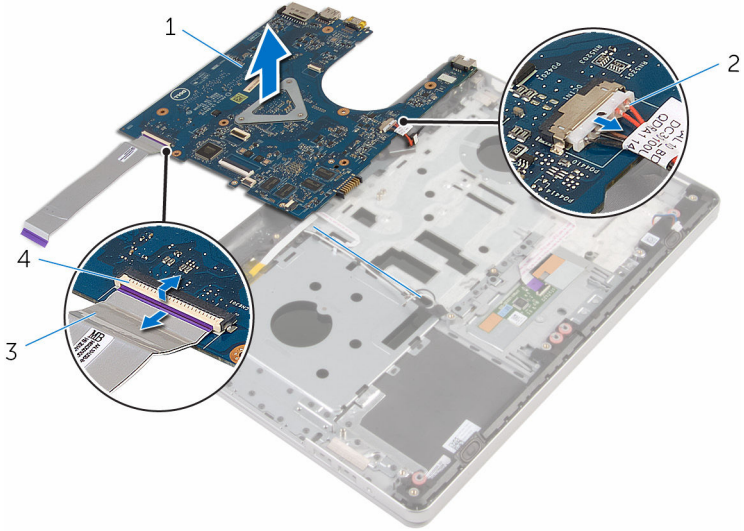

1 system board

2 power-adaptor port cable

3 I/O-board cable

4 latch



Replacing the system board



WARNING: Before working inside your computer, read the safety information that shipped with your computer and follow the steps in [Before working inside your computer](#). After working inside your computer, follow the instructions in [After working inside your computer](#). For more safety best practices, see the Regulatory Compliance home page at www.dell.com/regulatory_compliance.



NOTE: Your computer's Service Tag is stored in the system board. You must enter the Service Tag in the BIOS setup program after you replace the system board.



NOTE: Replacing the system board removes any changes you have made to the BIOS using the BIOS setup program. You must make the appropriate changes again after you replace the system board.

Procedure

- 1 Connect the power-adaptor port cable to the system board.



CAUTION: To avoid damaging the system board, ensure that no cables are placed under it.

- 2 Slide the I/O-board cable into its connector on the system board and press down the latch to secure the cable.
- 3 Connect the power-adaptor port cable to the system board
- 4 Turn the system board over.
- 5 Slide the ports on the system board into the slots on the palm-rest assembly and place the system board on the palm-rest assembly.
- 6 Align the screw hole on the system board with the screw hole on the palm-rest assembly.
- 7 Replace the screw that secures the system board to the palm-rest assembly.
- 8 Adhere the tape to the antenna cables.
- 9 Connect the speaker cable to the system board.
- 10 Slide the display cable into its connector on the system board and press down the latch to secure the cable.

- 11 Turn the computer over and open the display as far as possible.
- 12 Slide the touch-pad cable and the power-button board cable into their connectors on the system board and press down the latches to secure the cables.

Post-requisites

- 1 Replace the [I/O board](#).
- 2 Replace the [heat-sink assembly](#).
- 3 Replace the [computer base](#).
- 4 Replace the [keyboard](#).
- 5 Replace the [wireless card](#).
- 6 Follow the procedure from step 5 to step 7 in "[Replacing the hard drive](#)".
- 7 Replace the [memory modules](#).
- 8 Replace the [optical drive](#).
- 9 Replace the [base cover](#).
- 10 Replace the [battery](#).



Removing the power-adapter port



WARNING: Before working inside your computer, read the safety information that shipped with your computer and follow the steps in [Before working inside your computer](#). After working inside your computer, follow the instructions in [After working inside your computer](#). For more safety best practices, see the Regulatory Compliance home page at www.dell.com/regulatory_compliance.

Prerequisites

- 1 Remove the [battery](#).
- 2 Remove the [base cover](#).
- 3 Remove the [optical drive](#).
- 4 Remove the [memory modules](#).
- 5 Follow the procedure from step 1 to step 3 in "[Removing the hard drive](#)".
- 6 Remove the [wireless card](#).
- 7 Remove the [keyboard](#).
- 8 Remove the [computer base](#).
- 9 Remove the [heat-sink assembly](#).
- 10 Remove the [I/O board](#).
- 11 Remove the [system board](#).

Procedure

- 1 Note the power-adapter-port cable routing and remove the cable from its routing guides on the palm-rest assembly.
- 2 Remove the screw that secures the power-adapter port to the palm-rest assembly.

- 3** Lift the power-adapter port, along with the power-adapter port cable, off the palm-rest assembly.

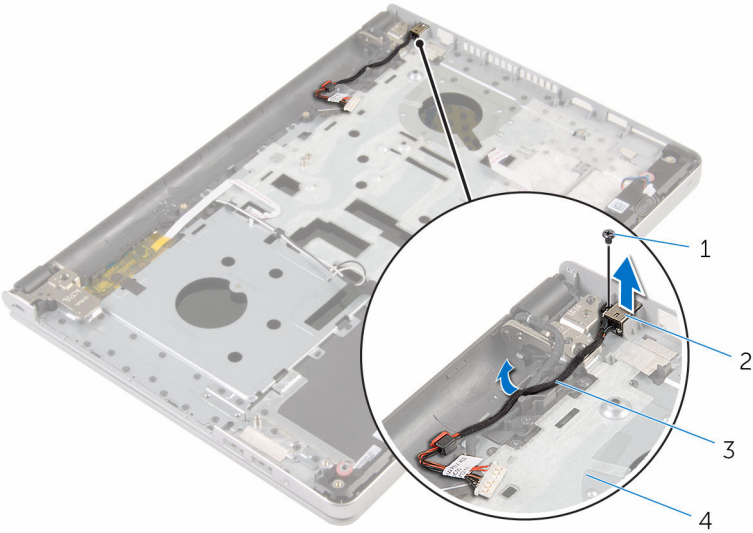

1 screw

2 power-adapter port

3 power-adapter port cable

4 palm-rest assembly



Replacing the power-adapter port



WARNING: Before working inside your computer, read the safety information that shipped with your computer and follow the steps in [Before working inside your computer](#). After working inside your computer, follow the instructions in [After working inside your computer](#). For more safety best practices, see the Regulatory Compliance home page at www.dell.com/regulatory_compliance.

Procedure

- 1 Place the power-adapter port into the slot on the palm-rest assembly.
- 2 Route the power-adapter port cable through its routing guides on the palm-rest assembly.
- 3 Replace the screw that secures the power-adapter port to the palm-rest assembly.

Post-requisites

- 1 Replace the [system board](#).
- 2 Replace the [I/O board](#).
- 3 Replace the [heat-sink assembly](#).
- 4 Replace the [computer base](#).
- 5 Replace the [keyboard](#).
- 6 Replace the [wireless card](#).
- 7 Follow the procedure from step 5 to step 7 in "[Replacing the hard drive](#)".
- 8 Replace the [memory modules](#).
- 9 Replace the [optical drive](#).
- 10 Replace the [base cover](#).
- 11 Replace the [battery](#).

Removing the power-button board



WARNING: Before working inside your computer, read the safety information that shipped with your computer and follow the steps in [Before working inside your computer](#). After working inside your computer, follow the instructions in [After working inside your computer](#). For more safety best practices, see the Regulatory Compliance home page at www.dell.com/regulatory_compliance.

Prerequisites

- 1 Remove the [battery](#).
- 2 Remove the [base cover](#).
- 3 Remove the [optical drive](#).
- 4 Remove the [memory modules](#).
- 5 Follow the procedure from step 1 to step 3 in "[Removing the hard drive](#)".
- 6 Remove the [wireless card](#).
- 7 Remove the [keyboard](#).
- 8 Remove the [computer base](#).
- 9 Remove the [heat-sink assembly](#).
- 10 Remove the [I/O board](#).
- 11 Remove the [system board](#).

Procedure

- 1 Remove the screw that secures the power-button board to the palm-rest assembly.
- 2 Peel the tape to access the power-button board.



3 Lift the power-button board, along with its cable, off the palm-rest assembly.

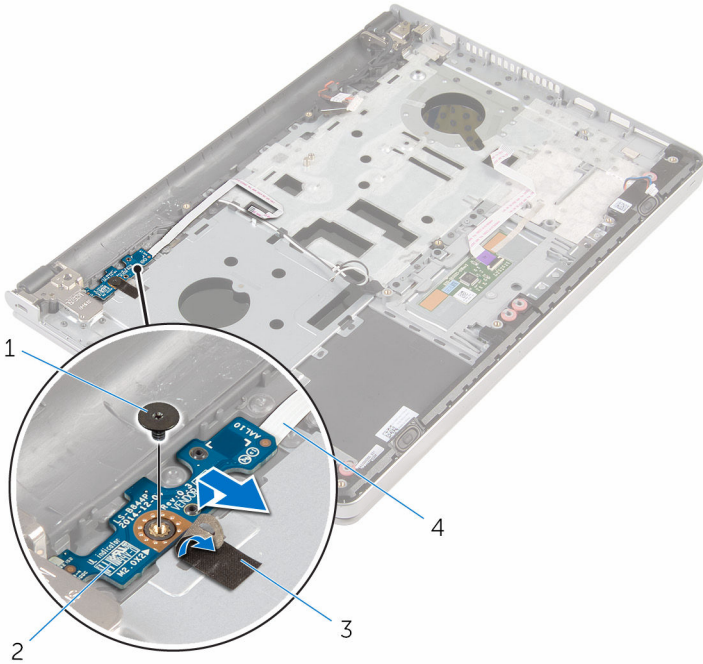

1 screw

2 power-button board

3 tape

4 power-button board cable

Replacing the power-button board



WARNING: Before working inside your computer, read the safety information that shipped with your computer and follow the steps in [Before working inside your computer](#). After working inside your computer, follow the instructions in [After working inside your computer](#). For more safety best practices, see the Regulatory Compliance home page at www.dell.com/regulatory_compliance.

Procedure

- 1 Align the screw hole on the power-button board with the screw hole on the palm-rest assembly.
- 2 Adhere the tape on the power-button board.
- 3 Replace the screw that secures the power-button board to the palm-rest assembly.

Post-requisites

- 1 Replace the [system board](#).
- 2 Replace the [I/O board](#).
- 3 Replace the [heat-sink assembly](#).
- 4 Replace the [computer base](#).
- 5 Replace the [keyboard](#).
- 6 Replace the [wireless card](#).
- 7 Follow the procedure from step 5 to step 7 in "[Replacing the hard drive](#)".
- 8 Replace the [memory modules](#).
- 9 Replace the [optical drive](#).
- 10 Replace the [base cover](#).
- 11 Replace the [battery](#).



Removing the speakers



WARNING: Before working inside your computer, read the safety information that shipped with your computer and follow the steps in [Before working inside your computer](#). After working inside your computer, follow the instructions in [After working inside your computer](#). For more safety best practices, see the Regulatory Compliance home page at www.dell.com/regulatory_compliance.

Prerequisites

- 1 Remove the [battery](#).
- 2 Remove the [base cover](#).
- 3 Remove the [optical drive](#).
- 4 Follow the procedure from step 1 to step 3 in "[Removing the hard drive](#)".
- 5 Remove the [wireless card](#).
- 6 Remove the [keyboard](#).
- 7 Remove the [computer base](#).

Procedure

- 1 Disconnect the speaker cable from the system board.

2 Lift the speakers, along with the speaker cable, off the palm-rest assembly.



1 speaker cable

2 speakers (2)

3 palm-rest assembly



Replacing the speakers



WARNING: Before working inside your computer, read the safety information that shipped with your computer and follow the steps in [Before working inside your computer](#). After working inside your computer, follow the instructions in [After working inside your computer](#). For more safety best practices, see the Regulatory Compliance home page at www.dell.com/regulatory_compliance.

Procedure

- 1 Using the alignment posts, align and place the speakers on the palm-rest assembly.
- 2 Connect the speaker cable to the system board.

Post-requisites

- 1 Replace the [computer base](#).
- 2 Replace the [keyboard](#).
- 3 Replace the [wireless card](#).
- 4 Follow the procedure from step 5 to step 7 in "[Replacing the hard drive](#)".
- 5 Replace the [optical drive](#).
- 6 Replace the [base cover](#).
- 7 Replace the [battery](#).

Removing the display assembly



WARNING: Before working inside your computer, read the safety information that shipped with your computer and follow the steps in [Before working inside your computer](#). After working inside your computer, follow the instructions in [After working inside your computer](#). For more safety best practices, see the Regulatory Compliance home page at www.dell.com/regulatory_compliance.

Prerequisites

- 1 Remove the [battery](#).
- 2 Remove the [base cover](#).
- 3 Remove the [optical drive](#).
- 4 Remove the [memory modules](#).
- 5 Follow the procedure from step 1 to step 3 in "[Removing the hard drive](#)".
- 6 Remove the [wireless card](#).
- 7 Remove the [keyboard](#).
- 8 Remove the [computer base](#).
- 9 Remove the [heat-sink assembly](#).
- 10 Remove the [I/O board](#).
- 11 Remove the [system board](#).

Procedure

- 1 Note the antenna-cable routing and remove the antenna cables from its routing guides on the palm-rest assembly.



- 2 Note the display-cable routing and remove the cable from its routing guides on the palm-rest assembly.

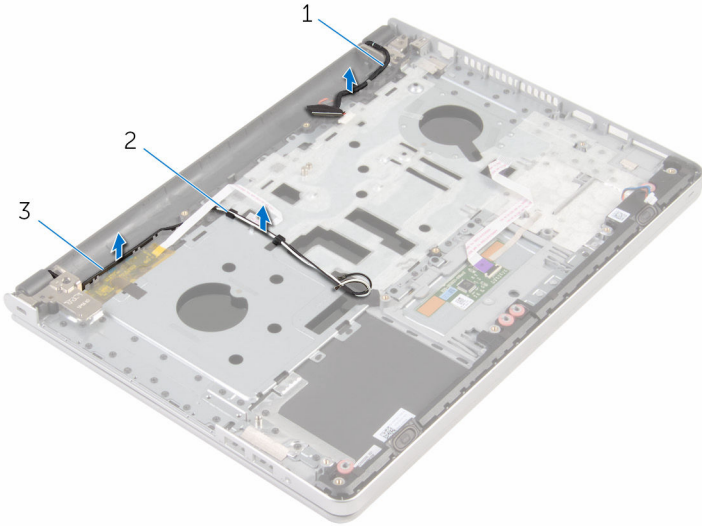

1 display cable

2 routing guides

3 antenna cables (2)

- 3 Turn the computer over and open the display at an angle of 90 degrees.
- 4 Turn the computer over and place it on the edge of the table in a position that allows access to the screws on the display hinges.
- 5 Remove the screws that secure the display hinges to the palm-rest assembly.

6 Carefully lift the display assembly from the palm-rest assembly.

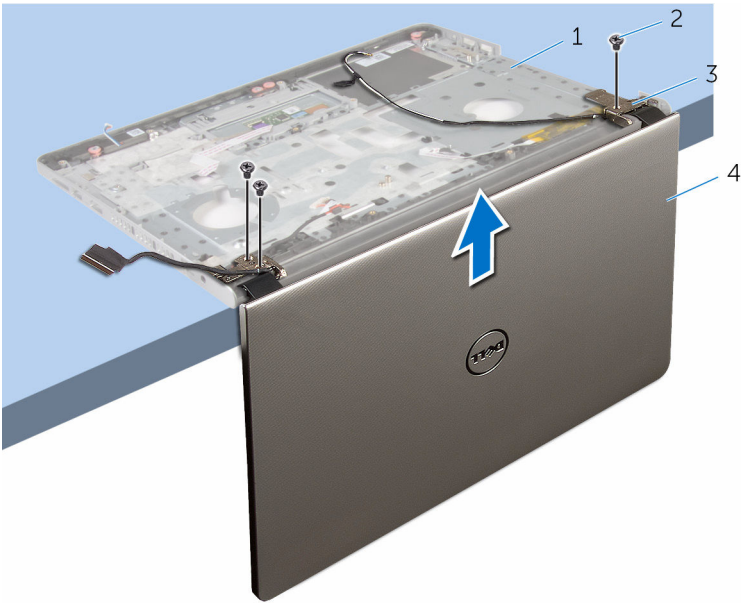

- 1 computer base
- 3 display hinges (2)

- 2 screws (3)
- 4 display assembly



- 7 Carefully place the display assembly on a clean, flat surface.



- 1 display assembly

Replacing the display assembly



WARNING: Before working inside your computer, read the safety information that shipped with your computer and follow the steps in [Before working inside your computer](#). After working inside your computer, follow the instructions in [After working inside your computer](#). For more safety best practices, see the Regulatory Compliance home page at www.dell.com/regulatory_compliance.

Procedure

- 1 Place the palm rest at the edge of the table with the speakers facing away from the edge.
- 2 Align the screw holes on the palm-rest assembly with the screw holes on the display hinges.
- 3 Replace the screws that secure the display hinges to the palm-rest assembly.
- 4 Route the antenna cables through its routing guides on the palm-rest assembly.
- 5 Route the display cable through its routing guides on the palm-rest assembly.

Post-requisites

- 1 Replace the [system board](#).
- 2 Replace the [I/O board](#).
- 3 Replace the [heat-sink assembly](#).
- 4 Replace the [computer base](#).
- 5 Replace the [keyboard](#).
- 6 Replace the [wireless card](#).
- 7 Follow the procedure from step 5 to step 7 in "[Replacing the hard drive](#)".
- 8 Replace the [memory modules](#).
- 9 Replace the [optical drive](#).
- 10 Replace the [base cover](#).
- 11 Replace the [battery](#).



Removing the palm-rest assembly



WARNING: Before working inside your computer, read the safety information that shipped with your computer and follow the steps in [Before working inside your computer](#). After working inside your computer, follow the instructions in [After working inside your computer](#). For more safety best practices, see the Regulatory Compliance home page at www.dell.com/regulatory_compliance.

Prerequisites

- 1 Remove the [battery](#).
- 2 Remove the [base cover](#).
- 3 Remove the [optical drive](#).
- 4 Remove the [memory modules](#).
- 5 Follow the procedure from step 1 to step 3 in "[Removing the hard drive](#)".
- 6 Remove the [wireless card](#).
- 7 Remove the [keyboard](#).
- 8 Remove the [computer base](#).
- 9 Remove the [speakers](#).
- 10 Remove the [heat-sink assembly](#).
- 11 Remove the [I/O board](#).
- 12 Remove the [system board](#).
- 13 Remove the [power-adapter port](#).
- 14 Remove the [power-button board](#).
- 15 Remove the [display assembly](#).

Procedure

After performing the steps in the prerequisites we are left with the palm-rest assembly.

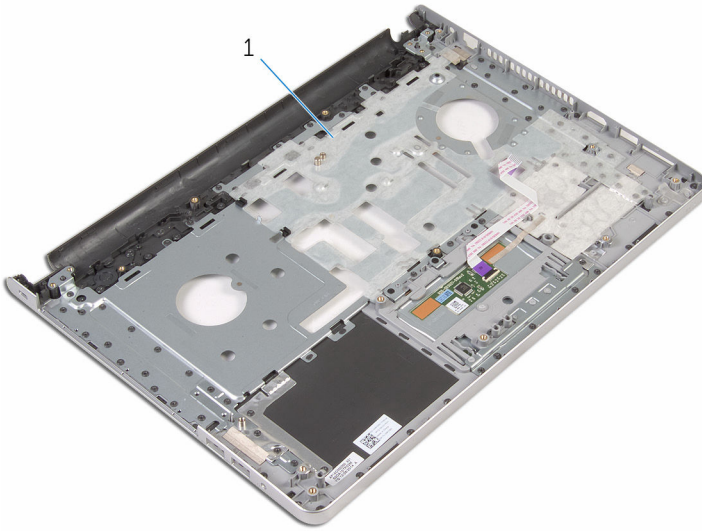

1 palm-rest assembly

Replacing the palm-rest assembly



WARNING: Before working inside your computer, read the safety information that shipped with your computer and follow the steps in [Before working inside your computer](#). After working inside your computer, follow the instructions in [After working inside your computer](#). For more safety best practices, see the Regulatory Compliance home page at www.dell.com/regulatory_compliance.

Procedure

Place the palm-rest assembly on a clean and flat surface.

Post-requisites

- 1 Replace the [display assembly](#).
- 2 Replace the [power-button board](#).
- 3 Replace the [power-adapter port](#).
- 4 Replace the [system board](#).
- 5 Replace the [I/O board](#).
- 6 Replace the [heat-sink assembly](#).
- 7 Replace the [speakers](#).
- 8 Replace the [computer base](#).
- 9 Replace the [keyboard](#).
- 10 Replace the [wireless card](#).
- 11 Follow the procedure from step 5 to step 7 in "[Replacing the hard drive](#)".
- 12 Replace the [memory modules](#).
- 13 Replace the [optical drive](#).
- 14 Replace the [base cover](#).
- 15 Replace the [battery](#).

Removing the display bezel



WARNING: Before working inside your computer, read the safety information that shipped with your computer and follow the steps in [Before working inside your computer](#). After working inside your computer, follow the instructions in [After working inside your computer](#). For more safety best practices, see the Regulatory Compliance home page at www.dell.com/regulatory_compliance.

Prerequisites



NOTE: These instructions are applicable only for laptops with a non-touch screen display.

- 1 Remove the [battery](#).
- 2 Remove the [base cover](#).
- 3 Remove the [optical drive](#).
- 4 Remove the [memory modules](#).
- 5 Follow the procedure from step 1 to step 3 in "[Removing the hard drive](#)".
- 6 Remove the [wireless card](#).
- 7 Remove the [keyboard](#).
- 8 Remove the [computer base](#).
- 9 Remove the [heat-sink assembly](#).
- 10 Remove the [I/O board](#).
- 11 Remove the [system board](#).
- 12 Remove the [display assembly](#).



Procedure

- 1 Using your fingertips, gently pry up the inner edges of the display bezel.

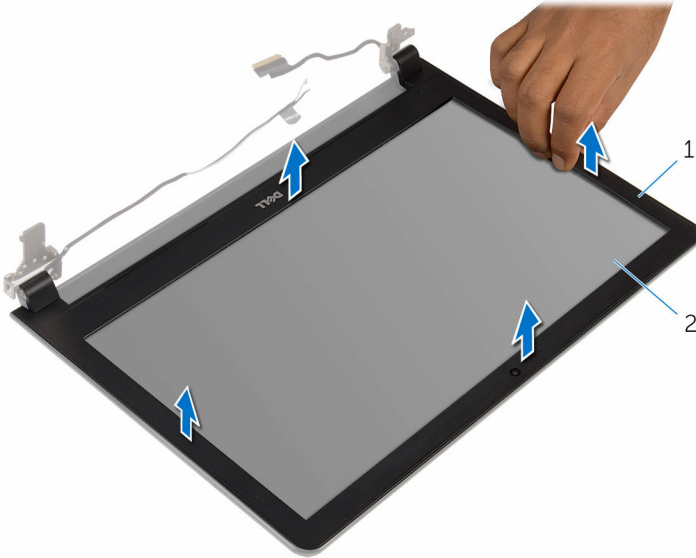

1 display bezel

2 display panel

- 2 Lift the display bezel off the display assembly.

Replacing the display bezel



WARNING: Before working inside your computer, read the safety information that shipped with your computer and follow the steps in [Before working inside your computer](#). After working inside your computer, follow the instructions in [After working inside your computer](#). For more safety best practices, see the Regulatory Compliance home page at www.dell.com/regulatory_compliance.

Procedure

Align the display bezel with the display back-cover and gently snap the display bezel into place.

Post-requisites

- 1 Replace the [display assembly](#).
- 2 Replace the [system board](#).
- 3 Replace the [I/O board](#).
- 4 Replace the [heat-sink assembly](#).
- 5 Replace the [computer base](#).
- 6 Replace the [keyboard](#).
- 7 Replace the [wireless card](#).
- 8 Follow the procedure from step 5 to step 7 in "[Replacing the hard drive](#)".
- 9 Replace the [memory modules](#).
- 10 Replace the [optical drive](#).
- 11 Replace the [base cover](#).
- 12 Replace the [battery](#).



Removing the camera



WARNING: Before working inside your computer, read the safety information that shipped with your computer and follow the steps in [Before working inside your computer](#). After working inside your computer, follow the instructions in [After working inside your computer](#). For more safety best practices, see the Regulatory Compliance home page at www.dell.com/regulatory_compliance.

Prerequisites



NOTE: These instructions are applicable only for laptops with a non-touchscreen display.

- 1 Remove the [battery](#).
- 2 Remove the [base cover](#).
- 3 Remove the [optical drive](#).
- 4 Remove the [memory modules](#).
- 5 Follow the procedure from step 1 to step 3 in "[Removing the hard drive](#)".
- 6 Remove the [wireless card](#).
- 7 Remove the [keyboard](#).
- 8 Remove the [computer base](#).
- 9 Remove the [heat-sink assembly](#).
- 10 Remove the [I/O board](#).
- 11 Remove the [system board](#).
- 12 Remove the [display assembly](#).
- 13 Remove the [display bezel](#).

Procedure

- 1 Disconnect the camera cable from the camera.

2 Using a plastic scribe, gently pry the camera off the display back-cover.

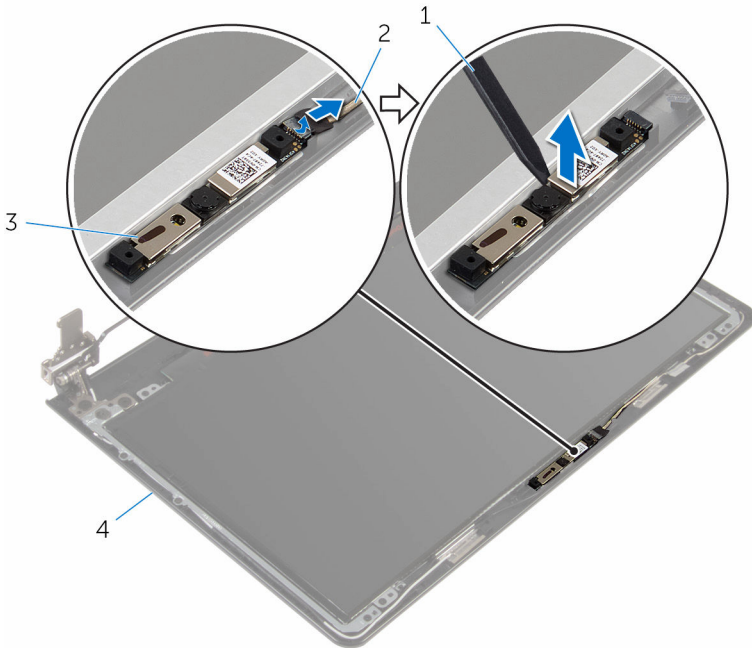

1 plastic scribe

2 camera cable

3 camera

4 display back-cover



Replacing the camera



WARNING: Before working inside your computer, read the safety information that shipped with your computer and follow the steps in [Before working inside your computer](#). After working inside your computer, follow the instructions in [After working inside your computer](#). For more safety best practices, see the Regulatory Compliance home page at www.dell.com/regulatory_compliance.

Procedure

- 1 Align the camera to the slot on the display back-cover and adhere the camera in place.
- 2 Connect the camera cable to the camera.

Post-requisites

- 1 Replace the [display bezel](#).
- 2 Replace the [display assembly](#).
- 3 Replace the [system board](#).
- 4 Replace the [I/O board](#).
- 5 Replace the [heat-sink assembly](#).
- 6 Replace the [computer base](#).
- 7 Replace the [keyboard](#).
- 8 Replace the [wireless card](#).
- 9 Follow the procedure from step 5 to step 7 in "[Replacing the hard drive](#)".
- 10 Replace the [memory modules](#).
- 11 Replace the [optical drive](#).
- 12 Replace the [base cover](#).
- 13 Replace the [battery](#).

Removing the display panel



WARNING: Before working inside your computer, read the safety information that shipped with your computer and follow the steps in [Before working inside your computer](#). After working inside your computer, follow the instructions in [After working inside your computer](#). For more safety best practices, see the Regulatory Compliance home page at www.dell.com/regulatory_compliance.

Prerequisites



NOTE: These instructions are applicable only for laptops with a non-touch screen display.

- 1 Remove the [battery](#).
- 2 Remove the [base cover](#).
- 3 Remove the [optical drive](#).
- 4 Remove the [memory modules](#).
- 5 Follow the procedure from step 1 to step 3 in "[Removing the hard drive](#)".
- 6 Remove the [wireless card](#).
- 7 Remove the [keyboard](#).
- 8 Remove the [computer base](#).
- 9 Remove the [heat-sink assembly](#).
- 10 Remove the [I/O board](#).
- 11 Remove the [system board](#).
- 12 Remove the [display assembly](#).
- 13 Remove the [display bezel](#).

Procedure

- 1 Remove the screws that secure the display panel to the display back-cover.



- 2** Turn the display panel over.

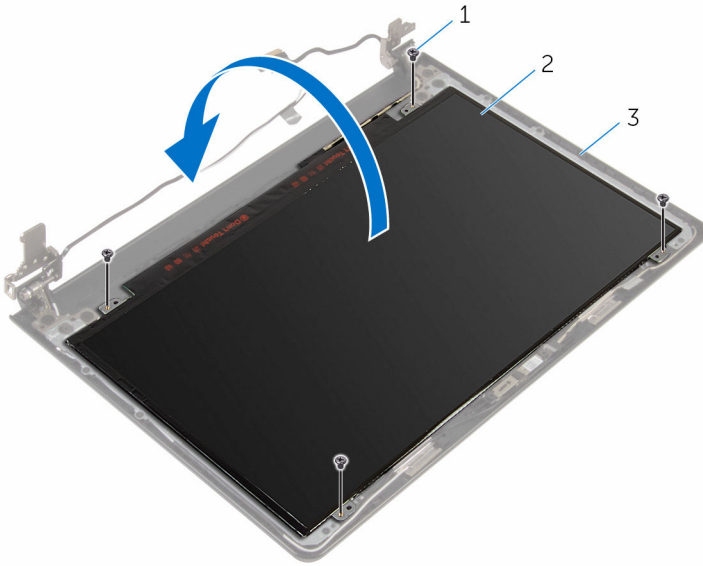

1 screws (4)

2 display panel

3 display-back cover

- 3** Peel the tape that secures the display cable to the display panel.
4 Lift the latch and disconnect the display cable from the display panel.

5 Lift the display panel off the display back-cover.

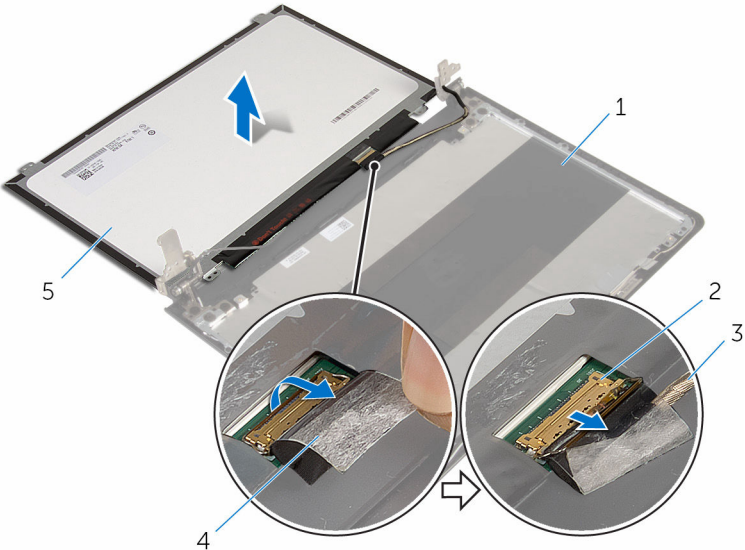

- 1 display back-cover
- 2 latch
- 3 display cable
- 4 tape
- 5 display panel



Replacing the display panel



WARNING: Before working inside your computer, read the safety information that shipped with your computer and follow the steps in [Before working inside your computer](#). After working inside your computer, follow the instructions in [After working inside your computer](#). For more safety best practices, see the Regulatory Compliance home page at www.dell.com/regulatory_compliance.

Procedure

- 1 Slide the display cable into the connector on the display panel and press down the latch to secure the cable.
- 2 Adhere the tape that secures the display cable to the display panel.
- 3 Turn the display panel over and place it on the display back-cover.
- 4 Align the screw holes on the display panel with the screw holes on the display back-cover.
- 5 Replace the screws that secure the display panel to the display back-cover.

Post-requisites

- 1 Replace the [display bezel](#).
- 2 Replace the [display assembly](#).
- 3 Replace the [system board](#).
- 4 Replace the [I/O board](#).
- 5 Replace the [heat-sink assembly](#).
- 6 Replace the [computer base](#).
- 7 Replace the [keyboard](#).
- 8 Replace the [wireless card](#).
- 9 Follow the procedure from step 5 to step 7 in "[Replacing the hard drive](#)".
- 10 Replace the [memory modules](#).
- 11 Replace the [optical drive](#).
- 12 Replace the [base cover](#).

13 Replace the [battery](#).



Removing the display hinges



WARNING: Before working inside your computer, read the safety information that shipped with your computer and follow the steps in [Before working inside your computer](#). After working inside your computer, follow the instructions in [After working inside your computer](#). For more safety best practices, see the Regulatory Compliance home page at www.dell.com/regulatory_compliance.

Prerequisites



NOTE: These instructions are applicable only for laptops with a non-touchscreen display.

- 1 Remove the [battery](#).
- 2 Remove the [base cover](#).
- 3 Remove the [optical drive](#).
- 4 Remove the [memory modules](#).
- 5 Follow the procedure from step 1 to step 3 in "[Removing the hard drive](#)".
- 6 Remove the [wireless card](#).
- 7 Remove the [keyboard](#).
- 8 Remove the [computer base](#).
- 9 Remove the [heat-sink assembly](#).
- 10 Remove the [I/O board](#).
- 11 Remove the [system board](#).
- 12 Remove the [display assembly](#).
- 13 Remove the [display bezel](#).
- 14 Remove the [display panel](#).

Procedure

- 1 Remove the screws that secure the display hinges to the display back-cover.

2 Carefully lift the display hinges off the display back-cover.

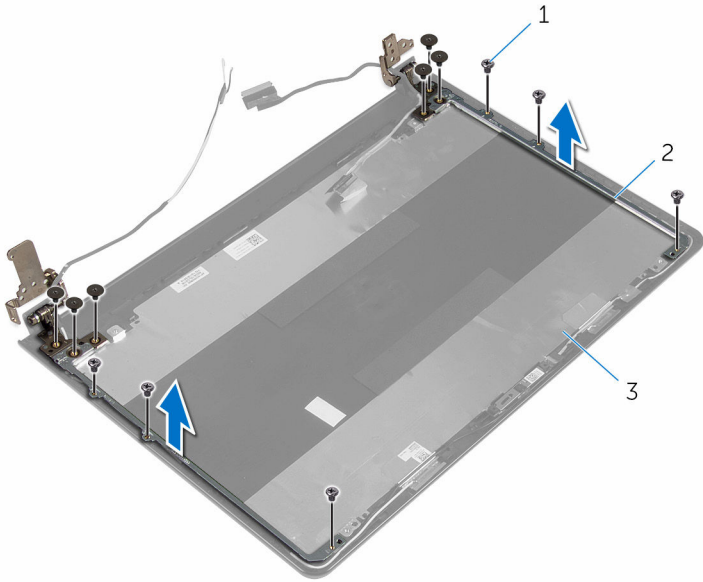

1 screws (12)

2 display hinges (2)

3 display back-cover



Replacing the display hinges



WARNING: Before working inside your computer, read the safety information that shipped with your computer and follow the steps in [Before working inside your computer](#). After working inside your computer, follow the instructions in [After working inside your computer](#). For more safety best practices, see the Regulatory Compliance home page at www.dell.com/regulatory_compliance.

Procedure

- 1 Align the screw holes on the display hinges with the screw holes on the display back-cover.
- 2 Replace the screws that secure the display hinges to the display back-cover.

Post-requisites

- 1 Replace the [display panel](#).
- 2 Replace the [display bezel](#).
- 3 Replace the [display assembly](#).
- 4 Replace the [system board](#).
- 5 Replace the [I/O board](#).
- 6 Replace the [heat-sink assembly](#).
- 7 Replace the [computer base](#).
- 8 Replace the [keyboard](#).
- 9 Replace the [wireless card](#).
- 10 Follow the procedure from step 5 to step 7 in "[Replacing the hard drive](#)".
- 11 Replace the [memory modules](#).
- 12 Replace the [optical drive](#).
- 13 Replace the [base cover](#).
- 14 Replace the [battery](#).

Removing the display cable



WARNING: Before working inside your computer, read the safety information that shipped with your computer and follow the steps in [Before working inside your computer](#). After working inside your computer, follow the instructions in [After working inside your computer](#). For more safety best practices, see the Regulatory Compliance home page at www.dell.com/regulatory_compliance.

Prerequisites



NOTE: These instructions are applicable only for laptops with a non-touchscreen display.

- 1 Remove the [battery](#).
- 2 Remove the [base cover](#).
- 3 Remove the [optical drive](#).
- 4 Remove the [memory modules](#).
- 5 Follow the procedure from step 1 to step 3 in "[Removing the hard drive](#)".
- 6 Remove the [wireless card](#).
- 7 Remove the [keyboard](#).
- 8 Remove the [computer base](#).
- 9 Remove the [heat-sink assembly](#).
- 10 Remove the [I/O board](#).
- 11 Remove the [system board](#).
- 12 Remove the [display assembly](#).
- 13 Remove the [display bezel](#).
- 14 Remove the [display panel](#).

Procedure

- 1 Peel off the tape that secures the camera cable to the display back-cover.
- 2 Disconnect the camera cable from the camera.



- 3 Note the display cable routing and remove the display cable from the routing guides on the display back-cover.
- 4 Note the camera cable routing and remove the camera cable from the display back-cover.

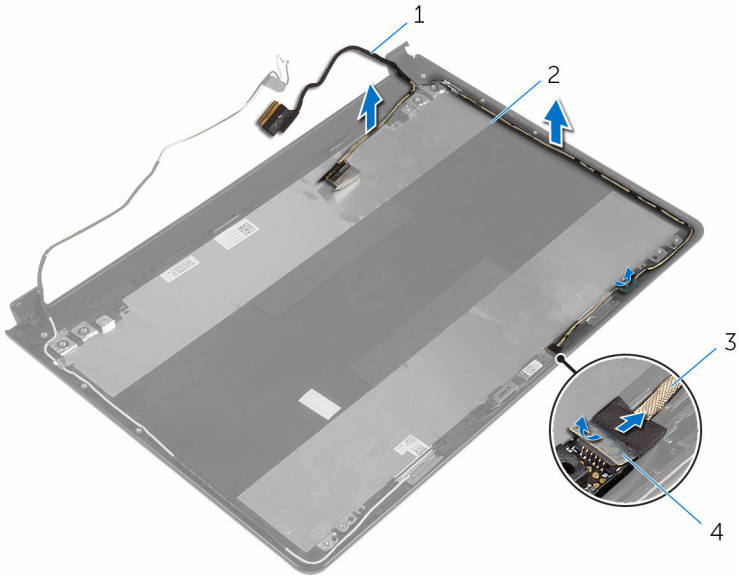

1 display cable

2 display back-cover

3 camera cable

4 tape

Replacing the display cable



WARNING: Before working inside your computer, read the safety information that shipped with your computer and follow the steps in [Before working inside your computer](#). After working inside your computer, follow the instructions in [After working inside your computer](#). For more safety best practices, see the Regulatory Compliance home page at www.dell.com/regulatory_compliance.

Procedure

- 1 Route the display cable through the routing guides on the display back-cover.
- 2 Connect the camera cable to the camera.
- 3 Adhere the tape that secures the camera cable to the display back-cover.

Post-requisites

- 1 Replace the [display hinges](#).
- 2 Replace the [display panel](#).
- 3 Replace the [display bezel](#).
- 4 Replace the [display assembly](#).
- 5 Replace the [system board](#).
- 6 Replace the [I/O board](#).
- 7 Replace the [heat-sink assembly](#).
- 8 Replace the [computer base](#).
- 9 Replace the [keyboard](#).
- 10 Replace the [wireless card](#).
- 11 Follow the procedure from step 5 to step 7 in "[Replacing the hard drive](#)".
- 12 Replace the [memory modules](#).
- 13 Replace the [optical drive](#).
- 14 Replace the [base cover](#).
- 15 Replace the [battery](#).



Removing the display back-cover and antenna assembly



WARNING: Before working inside your computer, read the safety information that shipped with your computer and follow the steps in [Before working inside your computer](#). After working inside your computer, follow the instructions in [After working inside your computer](#). For more safety best practices, see the Regulatory Compliance home page at www.dell.com/regulatory_compliance.

Prerequisites



NOTE: These instructions are applicable only for laptops with a non-touchscreen display.

- 1 Remove the [battery](#).
- 2 Remove the [base cover](#).
- 3 Remove the [optical drive](#).
- 4 Remove the [memory modules](#).
- 5 Follow the procedure from step 1 to step 3 in "[Removing the hard drive](#)".
- 6 Remove the [wireless card](#).
- 7 Remove the [keyboard](#).
- 8 Remove the [computer base](#).
- 9 Remove the [heat-sink assembly](#).
- 10 Remove the [I/O board](#).
- 11 Remove the [system board](#).
- 12 Remove the [display assembly](#).
- 13 Remove the [display bezel](#).
- 14 Remove the [camera](#).
- 15 Remove the [display panel](#).
- 16 Remove the [display cable](#).

Procedure

After performing the steps mentioned in the prerequisites, we are left with the display back-cover and antenna assembly.

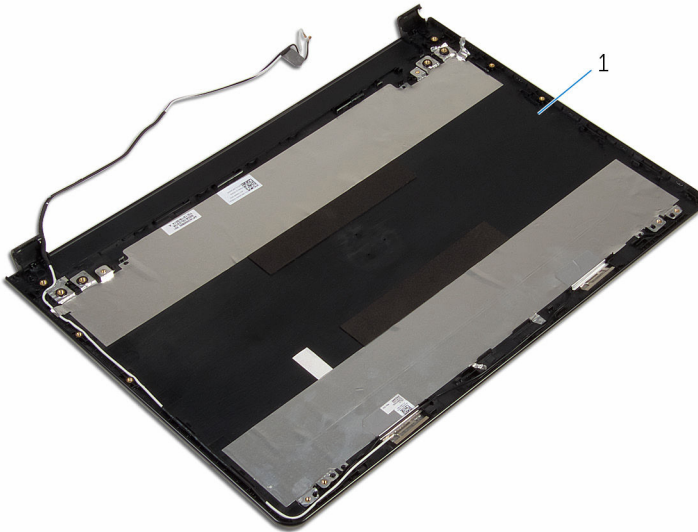

- 1 display back-cover and antenna assembly.

Replacing the display back-cover and antenna assembly



WARNING: Before working inside your computer, read the safety information that shipped with your computer and follow the steps in [Before working inside your computer](#). After working inside your computer, follow the instructions in [After working inside your computer](#). For more safety best practices, see the Regulatory Compliance home page at www.dell.com/regulatory_compliance.

Procedure

Place the display back-cover and antenna assembly on a clean, flat surface.

Post-requisites

- 1 Replace the [display cable](#).
- 2 Replace the [display hinges](#).
- 3 Replace the [display panel](#).
- 4 Replace the [camera](#).
- 5 Replace the [display bezel](#).
- 6 Replace the [display assembly](#).
- 7 Replace the [system board](#).
- 8 Replace the [I/O board](#).
- 9 Replace the [heat-sink assembly](#).
- 10 Replace the [computer base](#).
- 11 Replace the [keyboard](#).
- 12 Replace the [wireless card](#).
- 13 Follow the procedure from step 5 to step 7 in "[Replacing the hard drive](#)".
- 14 Replace the [memory modules](#).
- 15 Replace the [optical drive](#).
- 16 Replace the [base cover](#).

17 Replace the [battery](#).



Flashing the BIOS

You may need to flash (update) the BIOS when an update is available or when you replace the system board. To flash the BIOS:

- 1 Turn on your computer.
- 2 Go to www.dell.com/support.
- 3 Click **Product support**, enter the Service Tag of your computer, and then click **Submit**.



NOTE: If you do not have the Service Tag, use the auto-detect feature or manually browse for your computer model.

- 4 Click **Drivers & downloads** → **Find it myself**.
- 5 Select the operating system installed on your computer.
- 6 Scroll down the page and expand **BIOS**.
- 7 Click **Download** to download the latest version of the BIOS for your computer.
- 8 After the download is complete, navigate to the folder where you saved the BIOS update file.
- 9 Double-click the BIOS update file icon and follow the instructions on the screen.

Getting help and contacting Dell

Self-help resources

You can get information and help on Dell products and services using these self-help resources:

Information about Dell products and services

www.dell.com

Windows 8.1 and Windows 10

Dell Help & Support app



Windows 10

Get started app



Windows 8.1

Help + Tips app



Accessing help in Windows 8, Windows 8.1, and Windows 10

In Windows search, type **Help and Support**, and press Enter.

Accessing help in Windows 7

Click **Start** → **Help and Support**.

Online help for operating system

www.dell.com/support/windows

www.dell.com/support/linux

Troubleshooting information, user manuals, setup instructions, product specifications, technical help blogs, drivers, software updates, and so on.

www.dell.com/support

Learn about your operating system, setting up and using your computer, data backup, diagnostics, and so on.

See *Me and My Dell* at www.dell.com/support/manuals.



Contacting Dell

To contact Dell for sales, technical support, or customer service issues, see www.dell.com/contactdell.



NOTE: Availability varies by country and product, and some services may not be available in your country.



NOTE: If you do not have an active internet connection, you can find contact information on your purchase invoice, packing slip, bill, or Dell product catalog.

